

DOMINATORPLUS GAS RANGE APPLIANCES



USERS INSTRUCTIONS

SECTION 1 - GENERAL DESCRIPTION

SECTION 2 - LIGHTING and OPERATIONS

SECTION 3 - COOKING HINTS

SECTION 4 - CLEANING and MAINTENANCE

This appliance has been CE-marked on the basis of compliance with the Gas Appliance Directive for the Countries, Gas Types and Pressures as stated on the Data Plate.

The appliance MUST BE installed by a competent person in compliance with the INSTALLATION AND SERVICING INSTRUCTIONS and National Regulations in force at the time. Particular attention MUST be paid to the following:

Gas Safety (Installation & Use) Regulations

Health and Safety at Work Act

Furthermore, if a need arises to convert the appliance for use with another gas, a competent person must be consulted. Those parts which have been protected by the manufacturer MUST NOT be adjusted by the User.

Users should be conversant with the appropriate provisions of the Fire Precautions Act and the requirements of the Gas Safety Regulations. In particular the need for regular servicing by a competent person to ensure the continued safe and efficient performance of the appliance.

WARNING - TO PREVENT SHOCKS, ALL APPLIANCES WHETHER GAS OR ELECTRIC, MUST BE EARTHED.

Upon receipt of the User's Instruction manual, the installer must instruct the responsible person(s) of the correct operation and maintenance of the appliance. This equipment is ONLY FOR PROFESSIONAL USE, and shall be operated by QUALIFIED persons. It is the responsibility of the Supervisor or equivalent to ensure that users wear SUITABLE PROTECTIVE CLOTHING and to draw attention to the fact that, some parts will, by necessity, become VERY HOT and will cause burns if touched accidentally.



WEEE Directive Registration No. WEE/DC0059TT/PRO

At end of unit life, dispose of appliance and any replacement parts in a safe manner, via a licenced waste handler.

Units are designed to be dismantled easily and recycling of all material is encouraged whenever practicable.

Falcon Foodservice Equipment

HEAD OFFICE AND WORKS

Wallace View, Hillfoots Road, Stirling. FK9 5PY. Scotland.

SERVICELINE CONTACT

Phone: 01438 363 000

Fax: 01438 369 900

T100753 Ref.2

SECTION 1 - GENERAL DESCRIPTION

This group of products consists of the following models.

G3101 six burner open top range

G3161 four burner open top range

G3107 solid top range

G3121 six burner open top boiling table

G3124 four burner open top boiling table

G3127 solid top boiling table

G3117 general purpose oven

G3117 general purpose oven on stand

G3117/2 two tier general purpose oven

G3101D six burner open top range

G3107D solid top range

G3117D general purpose oven

G3117D general purpose oven on stand

Units are fitted with flame failure devices to shut off gas supply to burners if flames are extinguished.

The oven is thermostatically controlled.

Controls

All taps are the safety type with fixed HIGH and LOW settings. The markings are illustrated below.

Open Top Gas Tap

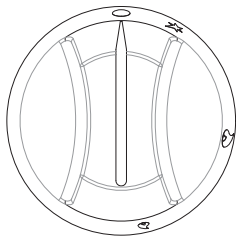

Figure 1

Solid Top Gas Tap

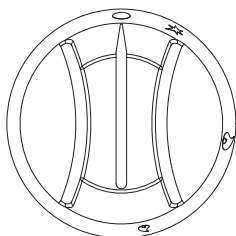

Figure 2

Oven Gas Tap

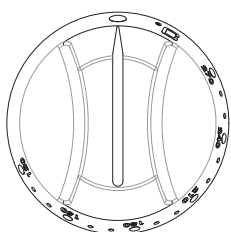

Figure 3

Each tap may be identified with the corresponding burner.

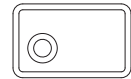
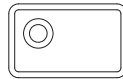

Figure 4

The oven is thermostatically controlled. Control knob markings are in degrees celcius and the control is identified by this symbol.



Figure 5

Note

Spark ignition button is located on control panel.

SECTION 2 - LIGHTING and OPERATIONS

Open Top

1. Ensure mains gas is sturned on.
2. Press and turn knob to full flame position.
3. Light burner using taper or match and continue to hold knob in for a further 20 seconds before release.
4. Burner should remain lit; if burner goes out return to Step 1 and repeat ignition procedure.
5. When burner remains lit, turn knob to required position.

To Shut Open Top Burner OFF

Turn knob to OFF position.

Using the Fryplate Accessory

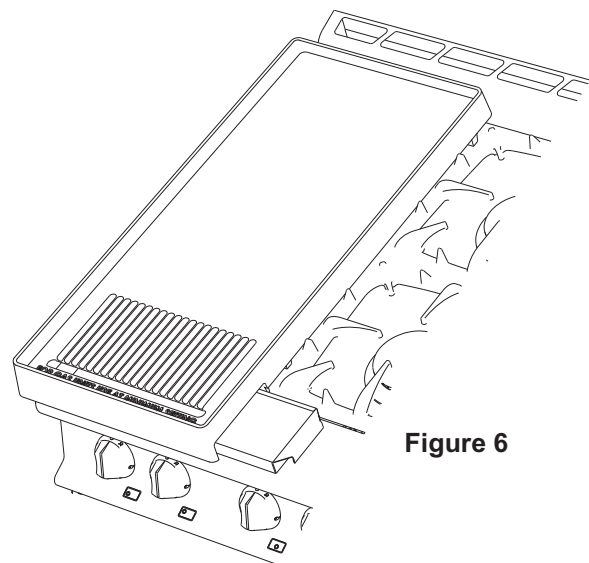

Figure 6

Important Note - Caution

This should only ever be used with hob burners on low flame setting.

The plate locates across any of the 3 banks of front and rear burners of the pan support casting.

A drain slot is located at plate front and a drainage tray slides below this from either side.

To remove or replace fryplate, lift it on and away from desired location as appropriate.

Allow plate to cool prior to any handling.

Solid Top

The solid hotplate is composed of two filling plates, a ring and centre bullseye. A double-ring burner is located below hotplate.

1. Ensure mains gas is turned on.
2. Remove bullseye castings from solid top hob.
3. Turn control anti-clockwise to pilot ignition position and push knob in.
4. Holding knob in fully, apply taper to pilot and observe pilot lights.
5. When pilot is lit, continue to hold knob in fully for 20 seconds then release. If pilot is extinguished, turn control off and wait three minutes. Repeat from Step 3.
6. Having established pilot condition, turn control knob anti-clockwise to FULL FLAME position. This will light main burner.
7. For LOW FLAME operation, turn control knob further anti-clockwise to LOW FLAME position.
8. Replace bullseye castings.
9. Minimum temperature of hottest solid top area is 295°C.

To Shut Solid Top Burner OFF

1. Turn to pilot position, ready for next operation.
2. To extinguish completely, turn to OFF position.

Oven

1. Ensure mains gas is sturned on.
2. Open oven doors.
3. Turn thermostat knob to maximum setting and push in. This will establish a flow of gas to oven burner.
4. Continue to press knob in and at the same time, push piezo ignitor button situated on control panel to provide a spark at oven burner.
5. Having established burner flame, maintain pressure on knob for a further 20 seconds before release.
6. Burner should remain lit. Should burner fail to remain lit, wait 3 minutes then return to Step 2 and repeat ignition procedure.
7. When burner remains lit, turn thermostat to required temperature setting.

To Shut Oven OFF

To extinguish burner, turn thermostat control knob to OFF position.

SECTION 3 - COOKING HINTS

Open Top

All open top burners are rated at 5.3kW nett.

The pan supports will safely accommodate pans from 125mm diameter (*minimum*) to 380mm diameter (*maximum*).

It should be noted that it is not advisable to use 6 pans of maximum size as this will impede performance and combustion.

Note - For maximum efficiency, place pan centrally over burner head. Adjust control setting to avoid flames licking up pan sides.

If using fryplate accessory, this requires to be seasoned prior to use.

Solid Top

It is normal practice to leave burner full on for entire time that hotplate is in use.

As much of the heat is concentrated at the centre, tapering away towards the edges, this area should be used for rapid boiling. The pan may then be moved away from main heat source to simmer at a desired intensity.

Hints on Using a Solid Hotplate

Getting the best out of this type of heat source is largely a matter of experience coupled with the needs of a particular task in hand. For certain applications, such as heating a pot quickly, it will be found expedient to remove centre ring and place pot directly over burner. Ring must be in position if it is necessary to heat the entire surface.

In the interests of fuel economy, it is recommended that the solid top is never left unattended at FULL setting. If it is necessary to keep hob hot for any length of time, control should be turned down to low flame setting.

NEVER leave gas on without a pot while centre ring is removed - such practice simply wastes gas.

The hottest areas are the centre and toward rear. Front and sides are cooler.

Models with Drop Down Door

Maximum weight to be placed upon door panel when open should never exceed 20kg.

The door should never be used as a step, nor should it be knelt on or sat on.

Oven

Temperature is automatically controlled by thermostat.

Caution: Opening oven door will result in the escape of heated air products. Care should be taken by users to avoid being burned by any such action.

Grid Shelves

Two cooking shelves are supplied which can be supported in any of five different positions within the oven. When two shelves are used, these should be positioned with at least one single shelf space between them. Always push shelves in until stops hit the front of the supports.

Tray Sizes

900mm wide oven will accommodate a 2/1 gastronorm tray. 600mm wide oven will accommodate a 1/1 gastronorm tray. Single trays or dishes should be positioned centrally. Trays must not be allowed to overhang the shelf in any direction as this will adversely affect heat circulation.

Pre-Heat Time

Allow at least 45 minutes from lighting a cold oven before a full load of food may be cooked. Air temperature will have reached control setting in 15 minutes. This pre-heat time may be suitable for lighter loads.

Insert food quickly and close doors firmly.

Oven Cooking Chart

This information is provided as guidance only. Figures are approximate and based on a G3101 oven. Due to the natural heat gradient in this type of oven, it will be necessary to interchange products on upper and lower shelves during cooking period.

Changeover timing varies according to product type, weight and temperature.

Food Products	Total Quantity	Total Weight (kg)	Temperature Setting (°C)	Runner Positions	Changeover Time (mins)	Total Cook Times (mins)
Vol-au-vents (medium)	80	1.1	230	2 & 4	10	16
Sultana scones (½")	80	4.5	240	2 & 4	9	14
Croissants (55g)	36	2	200	2 & 4	12	20
Bread rolls (75g)	48	3.6	230	2 & 4	10	17
Quiche lorraine (8" dia/680g)	12	8.2	195	2 & 4	35	60
Yorkshire pudding	72	2.7	240	3 & 5	18	32
Sponge (slab)	4	5.5	200	2 & 4	12	24
Baked jacket potatoes	72	26.5	220	2 & 4	70	110

SECTION 4 - CLEANING and MAINTENANCE

All surfaces are easier to clean if spillage is removed before it becomes burnt on and if unit is cleaned daily.

Stainless Steel Surfaces

These surfaces should be cleaned with hot water and detergent then dried and polished with a soft cloth.

Cleaning agents containing bleach, abrasives or caustic chemicals will damage or stain the stainless steel surfaces and must not be used.

Vitreous Enamel Surfaces

Approved cleaning agents which have the Vitreous Enamel Development Centre (VEDC) mark are recommended. It is advisable to clean daily after use. Wipe vitreous enamel surfaces clean while they are still warm using a soft cloth and hot soapy water. Badly stained, removable parts should be soaked in hot water with an approved detergent. Application of warm water using nylon or scotch cleaning pads with such detergent will give good results for non-removable parts.

Open Top Burners

Burner cleaning should be carried out daily.

Burner efficiency will be significantly reduced if recommended cleaning is not carried out.

Remove pan supports and open top burner heads.

Wash all parts with hot soapy water according to detailed instructions enclosed at end of section.

After washing, dry all parts well and ensure all water is removed from inside burner head.

Wipe hob area. Hob tray may be lifted off for cleaning purposes and is secured by ball stud fixings at each corner. To lift away, pull tray up by gripping through burner cut-outs.

Replace parts in reverse order. Ensure that all parts are located correctly. The semi-sealed hob must be pushed down fully on ball stud fixings.

Dry pan supports by hand.

NEVER LEAVE THESE TO DRY NATURALLY.

OVEN

To Clean The Oven

Clean while oven is warm but not hot. The enamelled base plate lifts out and runners can be removed (*grip at bottom, lift up until lower exit brackets, pull toward centre of oven and lower*).

CLEANING INSTRUCTIONS for OPEN TOP BURNERS

Figure 7

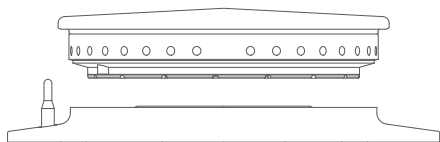

The following instructions should be followed when:

- A spillage has occurred on the burner.
- The burner fails to light or stay alight.
- At the end of each day or cooking period.

Caution

Parts will be hot therefore protection to avoid burns should be used.

Figure 8

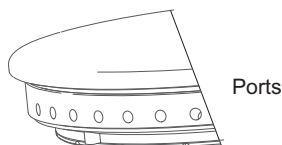

- Remove pan support.
- Remove burner head and bezel by lifting upward.
- Thoroughly clean with soap and water. Ensure all burner ports are clean and free from food or cleaning material debris.

Figure 9

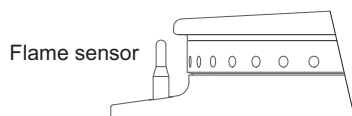

Important

Stubborn debris lodged in ports (See Figure 4) can be removed using a non-metallic implement (ie. cocktail stick). The slots in base should be freed of debris using a soft brush. Dry burner with a lint-free cloth and blow through ports to ensure there is no blockage.

Figure 10

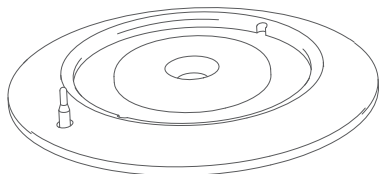

- Clean any spillage from burner base, ensuring all food and cleaning material debris is removed. Dry burner base thoroughly, taking care not to damage flame sensor.

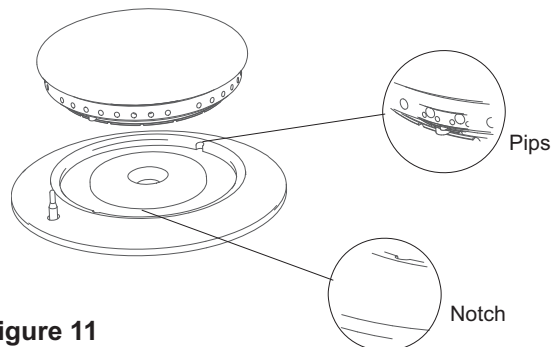

Figure 11

Important

Do not allow any spillage or cleaning material debris enter the large hole in the burner base.

- Replace burner head and aluminium bezel upon burner base and ensure head location pips sit within burner base notches. When burner head is properly located, it will not rotate.
- Light burner to check that it operates correctly.

Note: Parts MUST BE dried thoroughly prior to re-lighting.

Note

Follow this process prior to calling for a Service Engineer.

Failure due to lack of proper cleaning is not covered by warranty.

Cleaning the Fryplate Accessory (if used)

SECTION 5 - SPARE PARTS

The following parts may require replacing during the life of this appliance.

Control valve

Rear thermocouple

Front thermocouple

Oven thermostat

Neon light

Oven lamp

Oven light switch

Oven element

Oven fan

Note: Thermostat is supplied as standard with a natural gas bypass screw. When replacing this component on propane models, the bypass screw needs to be removed from faulty control to be replaced.